

REVISIONS			
REV.	DESCRIPTION	DATE	APPROVED
A	INITIAL RELEASE	2/23/2013	
B	ADDED M2 THREADED HOLES FOR ABILITY TO ADD LENS COVER IN THE FUTURE - METAPHASE LOGO ADDED TO SIDE PLATE.	12/20/2015	
C	CHANGED LOGO SIZE	10/25/2016	

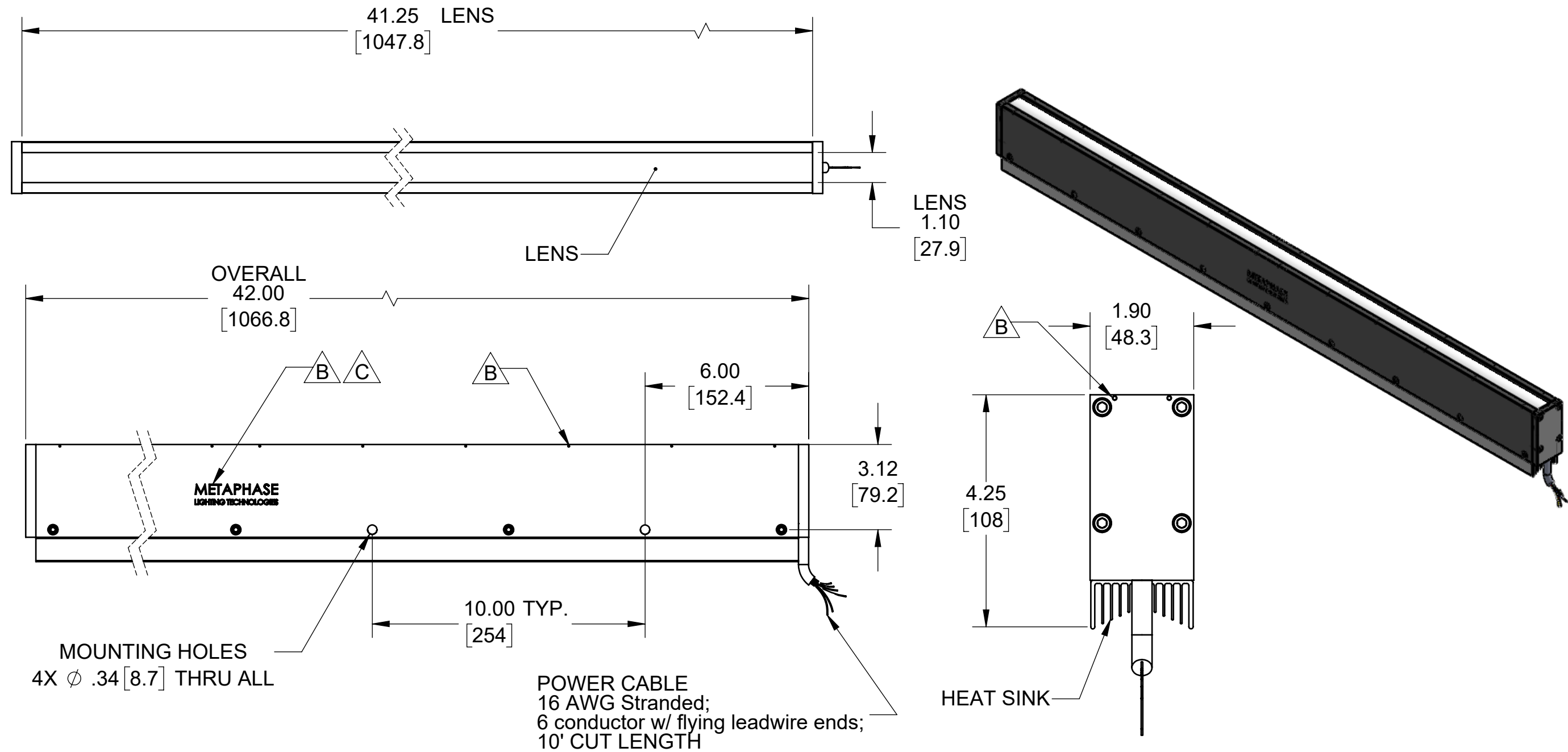

SEE SHEET 2 FOR EXPLODED VIEW AND BOM

Metaphase Technologies, Inc. 211 Sinclair Road, Suite 100, Bristol, PA. 19007 215-639-8699 Fax 215-639-0977



QUANTITY: Per order

MATERIAL: Per BOM

FINISH: Clear/Black Anodize

TREATMENT: N/A

TOLERANCE/FINISH UNLESS OTHERWISE SPECIFIED

INCHES [MM]				125V RMS [RA3.2um]
X	.X	.XX	.XXX	ANGLES ±1°
[±.76]	±.030 [±.25]	±.010 [±.13]	±.005	

THIS DOCUMENT IS THE PROPERTY OF METAPHASE TECHNOLOGIES, INC. WHOM MAY LOAN IT, SUBJECT TO RETURN UPON DEMAND. IT INCLUDES CONFIDENTIAL & PROPRIETARY INFORMATION WHICH MAY NOT BE DISCLOSED TO ANY THIRD PARTY, AND/ OR USED FOR ANY PURPOSE CONTRARY TO IT'S INTENDED USE, WITHOUT THE EXPRESSED PRIOR WRITTEN CONSENT OF METAPHASE TECHNOLOGIES, INC.

TITLE Top Assembly- 40" Line Light

USED ON Per customer

SIZE B	DRAWING NUMBER UL-LL909-1	REV C
SCALE 1:4		SHEET 1 OF 2

Approval Signature

/ /
Date